



Revolving Warning Beacons

# Girofari e lampeggianti

Catalogue

ITALIAN DESIGN  
QUALITY STANDARD  
CUSTOMIZED SOLUTIONS  
ERGONOMIC STUDY  
SAFETY APPROACH



IMEL Division

**LAMPEGGIANTE A LED 12V**

BARRE LED MAGNÉTIQUE  
MAGNETIC LED BAR  
MAGNETISCHE LED-LEISTE  
BARRA LED MAGNÉTICA

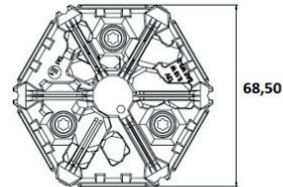
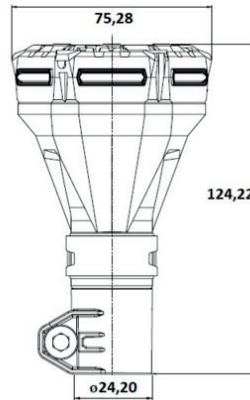

12 V



8,5W



-40°C a 70°C



IP67

Art./Ref.	Modello Model	N. LED	Assorbimento di corrente Current consumption	Fissaggio fixing	Materiali Material	Colore Color	Funzioni Functions	Materiale lente Lens material
68160	Base flex	36	0,65A	Punto più alto del veicolo	Base ABS+ fibra di vetro	Arancione	Flash singolo	Acrilico

**BARRA A LED MAGNETICA**

BARRE LED MAGNÉTIQUE  
MAGNETIC LED BAR  
MAGNETISCHE LED-LEISTE  
BARRA LED MAGNÉTICA

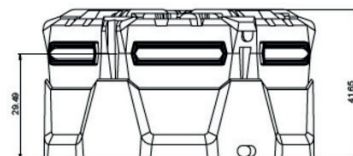
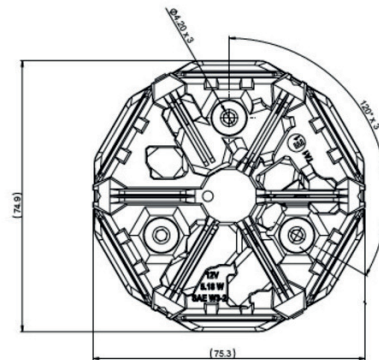

12V



8,5W



-40°C a 70°C



IP67

Art./Ref.	Modello Model	N. LED	Assorbimento di corrente Current consumption	Fissaggio fixing	Materiali Material	Colore Color	Funzioni Functions	Materiale lente Lens material
68161	base magnetica	36	0,65 A	Punto più alto del veicolo	Base ABS+fibra di vetro	Arancione	Flash singolo	Acrilico

**BARRA A LED MAGNETICA**

BARRE LED MAGNÉTIQUE  
MAGNETIC LED BAR  
MAGNETISCHE LED-LEISTE  
BARRA LED MAGNÉTICA

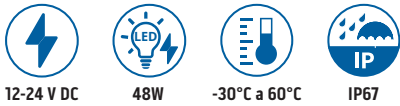
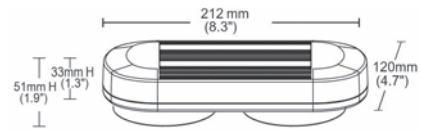

12-24 V DC    48W    -30°C a 60°C    IP67

Art./Ref.	Modello Model	N.LED	Fissaggio fixing	Materiali Material	Colore Color	Collegamento elettrico	Dimensioni/ Sizes	Note/ Notes
69400	Base magnetica	48	Magneti	Polycarbonato, alluminio	Luce arancio	Spina accendisigari	212 X 120 X 51	17 modalità flash

**BARRA A LED MAGNETICA**

BARRE LED MAGNÉTIQUE  
MAGNETIC LED BAR  
MAGNETISCHE LED-LEISTE  
BARRA LED MAGNÉTICA

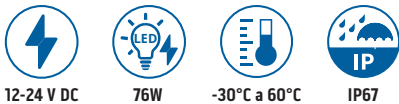
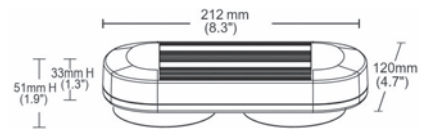

12-24 V DC    76W    -30°C a 60°C    IP67

Art./Ref.	Modello Model	N.LED	Fissaggio fixing	Materiali Material	Colore Color	Collegamento elettrico	Dimensioni/ Sizes	Note/ Notes
69401	Base magnetica	72	Magneti	Polycarbonato	Luce arancio	Spina accendisigari	362 X 170 X 61	26 modalità flash

**BARRA A LED MAGNETICA**

BARRE LED MAGNÉTIQUE  
MAGNETIC LED BAR  
MAGNETISCHE LED-LEISTE  
BARRA LED MAGNÉTICA

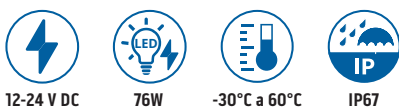
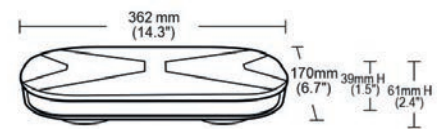

12-24 V DC    76W    -30°C a 60°C    IP67

Art./Ref.	Modello Model	N.LED	Fissaggio fixing	Materiali Material	Colore Color	Collegamento elettrico	Dimensioni/ Sizes	Note/ Notes
69402	Base magnetica	72	Magneti	Polycarbonato	Luce arancio	Spina accendisigari	363 X 171 X 55	26 modalità flash

### GIROFARO MAGNETICO A LED BATTERIA 12-24V

GYROPHARE A LED AVEC BATTERIE 12-24V  
 RECHARGEABLE LED BEACON 12-24V  
 WIEDERAUFLADBARE LED BEACON 12-24V  
 LUZ GIRATORIA LED CON BATERIA 12-24V

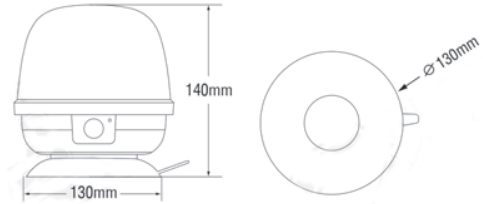

- 12/24V
- 22W
- 40°C a 65°C
- IP67
- MONTAGGIO/MOUNTING  
Fissaggio con magnete/Magnetic

#### RICAMBI/ SPARE PARTS

Art./Ref.	Descrizione
66009	Cavo con spina a ricambio
66008	Spina alimentazione 100-240V a ricambio

Art./Ref.	Colore/Color	Descrizione/Description	Configurazioni/Configurations	Note/Notes
66010	Ambra Amber	Durata batteria 6 ore, tempo di ricarica 4 ore/Discharging time 6 hours, charging time 4 hours	3 modalità flash e 4 modalità di rotazione	ECE-R10, ECE-R65 * se il girofaro è collegato all'alimentatore/ ECE-R10, ECE-R65 * must be plugged into the cigarette lighter

### GIROFARO LED A BATTERIA CON TELECOMANDO 12/24V

GYROPHARE A LED AVEC BATTERIE ET TÉLÉCOMMANDE 12 / 24V  
 RECHARGEABLE LED BEACON WITH REMOTE CONTROLLER  
 WIEDERAUFLADBARE LED-BLITZLEUCHTE MIT FERNBEDIENUNG 12/24V  
 LUZ GIRATORIA LED CON BATERIA Y CON MANDO A DISTANCIA 12-24V

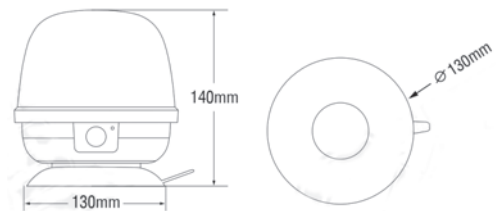

- 12/24V
- 22W
- 40°C a 65°C
- IP67
- MONTAGGIO/MOUNTING  
Fissaggio con magnete/Magnetic

#### RICAMBI/ SPARE PARTS

Art./Ref.	Descrizione
66009	Cavo con spina a ricambio
66008	Spina alimentazione 100-240V a ricambio
66149	Telecomando a ricambio

Art./Ref.	Colore/Color	Descrizione/Description	Configurazioni/Configurations	Note/Notes
66150	Ambra Amber	Durata batteria 6 ore, tempo di ricarica 4 ore/Discharging time 6 hours, charging time 4 hours	3 modalità flash e 4 modalità di rotazione	ECE-R10, ECE-R65 * se il girofaro è collegato all'alimentatore/ ECE-R10, ECE-R65 * must be plugged into the cigarette lighter

### GIROFARO LED A BATTERIA 12-24V

GYROPHARE A LED AVEC BATTERIE 12-24V  
 RECHARGEABLE LED BEACON 12-24V  
 WIEDERAUFLADBARE LED BEACON 12-24V  
 LUZ GIRATORIA LED CON BATERIA 12-24V

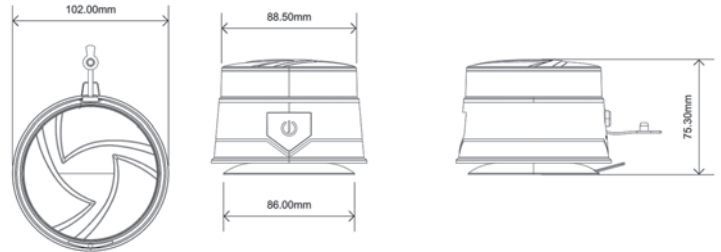

12/24V   
 19W   
 -40°C a 65°C   
 IP67   
 MONTAGGIO/MOUNTING  
 Fissaggio con magnete/Magnetic

#### RICAMBI/ SPARE PARTS

Art./Ref.	Descrizione
66009	Cavo con spina a ricambio
66008	Spina alimentazione 100-240V a ricambio

Art./Ref.	Ampere/ Ampere	Colore/ Color	Descrizione/ Description	Configurazioni/ Configurations	Note/Notes
68080	0,58A a 24V	Ambra/Amber	Durata della carica della batteria 6,5 ore, tempo di ricarica 4 ore/Discharging time 6,5 hours, charging time 4 hours	3 modalità flash e 4 modalità di rotazione/3 modes flash & 4 modes rotation	ECE-R10, ECE-R65 * se il girofaro è collegato all'alimentatore/ ECE-R10, ECE-R65 * must be plugged into the cigarette lighter

### GIROFARO LED A BATTERIA CON TELECOMANDO 12/24V

GYROPHARE A LED AVEC BATTERIE ET TÉLÉCOMMANDE 12/24V  
 RECHARGEABLE LED BEACON WITH REMOTE CONTROLLER 12/24V  
 WIEDERAUFLADBARE LED-BLITZLEUCHTE MIT FERNBEDIENUNG 12/24V  
 LUZ GIRATORIA LED CON BATERIA Y CON MANDO A DISTANCIA 12-24V

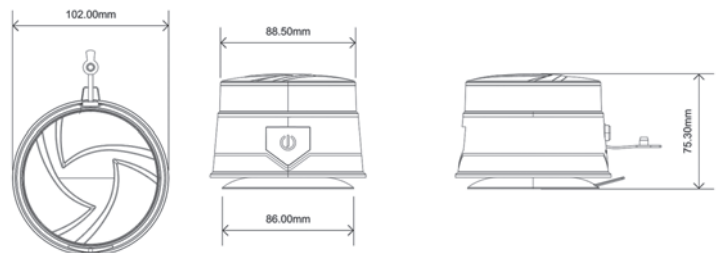

12/24V   
 19W   
 -40°C a 65°C   
 IP67   
 MONTAGGIO/MOUNTING  
 Fissaggio con magnete/Magnetic

#### RICAMBI/ SPARE PARTS

Art./Ref.	Descrizione
66009	Cavo con spina a ricambio
66008	Spina alimentazione 100-240V a ricambio
66149	Telecomando a ricambio

Art./Ref.	Ampere/ Ampere	Colore/ Color	Descrizione/ Description	Configurazioni/ Configurations	Note/Notes
68081	0,58A a 24V	Ambra/Amber	Durata della carica della batteria 6,5 ore, tempo di ricarica 4 ore/Discharging time 6,5 hours, charging time 4 hours	3 modalità flash e 4 modalità di rotazione/3 modes flash & 4 modes rotation	ECE-R10, ECE-R65 * se il girofaro è collegato all'alimentatore/ ECE-R10, ECE-R65 * must be plugged into the cigarette lighter

**LAMPEGGIANTI A LED 12/24V**

GYROPHARE A LED 12-24V  
LED BEACONS 12/24V  
DREHLEUCHTE LED 12-24V  
FAROS ROTATIVO 12-24V

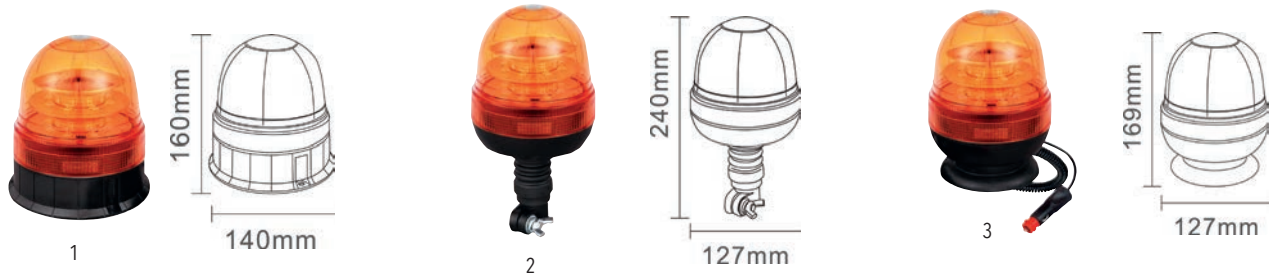

**RICAMBI/ SPARE PARTS**

Art./Ref.	Descrizione
59114	Calotta serie GEA ambrata in policarbonato
04593	Cavo spiralato con spina agricola ON/OFF

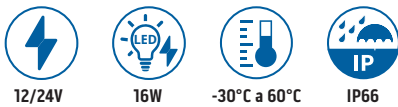

Art./Ref.	Pos.	Descrizione/Description	Configurazioni/Configurations	Colore/Color	Certificazione/Certification
62480	1	Base piana/ 3-Bolt fixing	Tre sistemi di luminosità: rotazione, flash singolo, flash veloce / Pattern: rotation, sigle flash, quick flash	Ambra/Amber	Certificazioni: CE EMC ECE R65, IP66
62481	2	Base flessibile con attacco ad asta/ Flex din	Tre sistemi di luminosità: rotazione, flash singolo, flash veloce / Pattern: rotation, sigle flash, quick flash	Ambra/Amber	Certificazioni: CE EMC ECE R65, IP66
62482	3	Base magnetica/ Magnetic base	Tre sistemi di luminosità: rotazione, flash singolo, flash veloce / Pattern: rotation, sigle flash, quick flash	Ambra/Amber	Certificazioni: CE EMC ECE R65, IP66
68695	2	Base flessibile con attacco ad asta/ Flex din	Tre sistemi di luminosità: rotazione, flash singolo, flash veloce / Pattern: rotation, sigle flash, quick flash	Verde/Green	Certificazioni: CE EMC ECE R65, IP66

**LAMPEGGIANTI A LED 12-24V**

GYROPHARE A LED 12-24V  
2-24V LED BEACONS  
DREHLEUCHTE LED 12-24V  
FAROS ROTATIVO 12-24V



**RICAMBI/ SPARE PARTS**

Art./Ref.	Descrizione
59113	Calotta ambrata serie ATENA
04593	Cavo spiralato con spina agricola ON/OFF

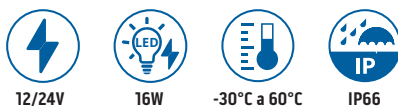

Art./Ref.	Descrizione/Description	Configurazioni/Configurations	Colore/Color	Certificazione/Certification
60116	Base piana/ 3-Bolt fixing	Tre sistemi di luminosità: rotazione, flash singolo, flash veloce / Pattern: rotation, sigle flash, quick flash	Ambra/Amber	Certificazioni: CE EMC ECE R65, IP66
60117	Base flessibile con attacco ad asta/ Flex din	Tre sistemi di luminosità: rotazione, flash singolo, flash veloce / Pattern: rotation, sigle flash, quick flash	Ambra/Amber	Certificazioni: CE EMC ECE R65, IP66
60118	Base magnetica/ Magnetic base	Tre sistemi di luminosità: rotazione, flash singolo, flash veloce / Pattern: rotation, sigle flash, quick flash	Ambra/Amber	Certificazioni: CE EMC ECE R65, IP66

## GIROFARI A LED 12-24V CON 7 VARIETA' DI FLASH SELEZIONABILI E SINCRONIZZABILI

GYROPHARES A LEDS 12-24 V AVEC 7 MOTIFS FLASH SÉLECTIONNÉS ET SYNCHRONISABLES  
 LED BEACONS 12-24V WITH 7 FLASH PATTERNS SELECTED & SYNCHRONIZABLES  
 LED-LEUCHTFEUER 12-24V, MIT 7 BLITZMUSTERN AUSGEWÄHLT & SYNCHRONIZIERBAR  
 GIROFAROS LED 12-24V CON 7 PATRONES DE FLASH SELECCIONADOS Y SINCRONIZABLES

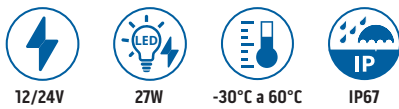

### RICAMBI/ SPARE PARTS

Art./Ref.	Descrizione
04597	Spina agricola c/cavo spir on/off e flash

Art./Ref.	Descrizione/Description	Configurazioni/Configurations	Ampere/Ampere	Posizione/Position	Colore/Color	Certificazione/Certification
63120	Base piana Mounting fix	7 modalità di flash: Flash singolo, doppio flash veloce, doppio flash veloce, Flash triplo, Flash quadruplo, Flash mega, Rotazione. Possibilità di sincronizzare i flash di oltre 15 girofari	12V- 7,7A; 24V-0,85A	112x46 mm	Ambra Amber	ECE R10, ECE R65
63121	Base magnetica/Magnetic base	7 modalità di flash: Flash singolo, doppio flash veloce, doppio flash veloce, Flash triplo, Flash quadruplo, Flash mega, Rotazione.	12V- 7,7A; 24V-0,85A	112x46 mm	Ambra Amber	ECE R10, ECE R65
63122	Base flessibile/Flexible mount	7 modalità di flash: Flash singolo, doppio flash veloce, doppio flash veloce, Flash triplo, Flash quadruplo, Flash mega, Rotazione.	12V- 7,7A; 24V-0,85A	112X140 mm	Ambra Amber	ECE R10, ECE R65
63129	Base magnetica/Magnetic base	7 modalità di flash: Flash singolo, doppio flash veloce, doppio flash veloce, Flash triplo, Flash quadruplo, Flash mega, Rotazione.	12V- 7,7A; 24V-0,85A	112x46 mm	Blu Blue	ECE R10, ECE R65

## GIROFARI A LED 12-24V

FEU À ÉCLATS 12-24V  
 LED BEACON 12-24V  
 LED-RUNDUMLEUCHTE 12-24V  
 FAROS ROTATIVO 12-24V

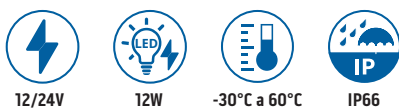

### RICAMBI/ SPARE PARTS

Art./Ref.	Descrizione
55404	Calotta ambra 55401/402/403
04593	Cavo spiralato con spina agricola ON/OFF

Art./Ref.	Pos.	Descrizione/Description	Ampere/Ampere	Colore/Color	Configurazioni/Configurations	Certificazione/Certification
55401	1	Base piana/ 3 bolts mount	12V-24V: 0,7A, 0,4A	Ambra Amber	Quattro tipologie di flash: Rotazione, Flash singolo Doppio flash, Triplo (Octa) flash.	ECE R65, ECE R10, CE
55402	2	Base magnetica/Magnetic	12V-24V: 0,7A, 0,4A	Ambra Amber	Quattro tipologie di flash: Rotazione, Flash singolo Doppio flash, Triplo (Octa) flash.	ECE R65, ECE R10, CE
55403	3	Base imbuto flessibile/Flexi Din mount	12V-24V: 0,7A, 0,4A	Ambra Amber	Quattro tipologie di flash: Rotazione, Flash singolo Doppio flash, Triplo (Octa) flash.	ECE R65, ECE R10, CE
55415	3	Base flessibile Flexible base	12-24 DC - 0,7-0,4	Verde Green	Quattro tipologie di flash: rotazione, flash singolo, doppio flash, quad flash	R10, CE, RoHS, UKCA
55416	3	Base flessibile Flexible base	12-24 DC - 0,7-0,4	Rosso Red	Quattro tipologie di flash: rotazione, flash singolo, doppio flash, quad flash	R10, CE, RoHS, UKCA

### GIROFARI A LED 12-24V

FEUX À ÉCLATS 12-24V

LED BEACONS 12-24V

LED-RUNDUMLEUCHTE 12-24V

GIROFAROS LED 12-24V

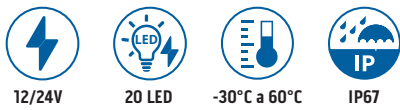
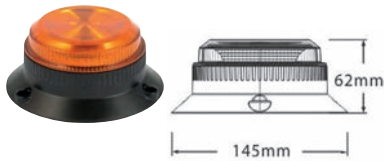

#### RICAMBI/ SPARE PARTS

Art./Ref.	Descrizione
63123	Calotta ambra per 63117-8-9
04593	Cavo spiralato con spina agricola ON/OFF

Art./Ref.	Descrizione/Description	Ampere/Ampere	Colore/Color	Configurazioni/Configurations	Certificazione/Certification
63117	Base piana/ 3 bolts mount	12V - 1,6A; 24V - 0,8A	Ambra/Amber	Quattro tipologie di flash: Flash singolo, Doppio flash, Quad flash, Mega flash	ECE R10, ECE R65, EMC, CE
63118	Base magnetica/ Magnetic/	12V - 1,6A; 24V - 0,8A	Ambra/Amber	Quattro tipologie di flash: Flash singolo, Doppio flash, Quad flash, Mega flash	ECE R10, ECE R65, EMC, CE
63119	Base imbuto flessibile/ Pole DIN/Flexi Din mount	12V - 1,6A; 24V - 0,8A	Ambra/Amber	Quattro tipologie di flash: Flash singolo, Doppio flash, Quad flash, Mega flash	ECE R10, ECE R65, EMC, CE

### LAMPEGGIANTE LED MINI 9-30V

GYROPHARE A LED MINI 9-30V

MINI WARNING BEACON 9-30V

MINI-WARNBLINKLEUCHTE LED 9-30V

MINI BALIZA GIRATORIA LED 9-30V

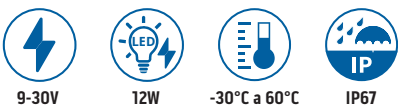
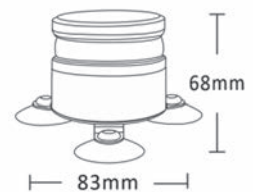

#### RICAMBI/ SPARE PARTS

Art./Ref.	Descrizione
04597	Spina agricola c/cavo spir on/off e flash

Art./Ref.	Colore/Color	Specifiche/Specifications	Configurazioni/Configurations	Materiale/Material	Note/Notes
68110	Ambra/Amber	Fissaggio con magnete o supporto con ventosa/Magnetic mounting or bracket with suction cup	6 modalità di rotazione/ 6 flash patterns	Base in lega di alluminio, calotta in PC/ Body: aluminium alloy; Len: PC	ECE R10, ECE-R65, IP67, CISPR25 Class 3/



## GIROFARI

FEU À ÉCLATS  
LED BEACON  
LED-RUNDUMLEUCHTE  
FAROS ROTATIVO



### RICAMBI/ SPARE PARTS

Art./Ref.	Descrizione
<b>63113</b>	Calotta ricambio
<b>08048</b>	Lampada 12 V H1
<b>08049</b>	Lampada 24 V H1
<b>04593</b>	Cavo spiralato con spina agricola ON/OFF

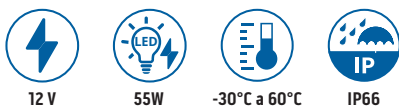

Art./Ref.	Specifiche/Specifications	Colore/Color	Note/Notes	Certificazione/Certification
<b>63110</b>	Base piana/Mounting fix	Ambra/ Amber	Oltre 10000 ore di lavoro	ECE R10, ECE R65
<b>63111</b>	Base magnetica/ Magnetic base	Ambra/ Amber	Oltre 10000 ore di lavoro	ECE R10, ECE R65
<b>63112</b>	Base flessibile/ Flexible mount	Ambra/ Amber	Oltre 10000 ore di lavoro	ECE R10, ECE R65

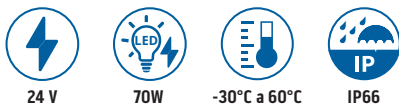

Art./Ref.	Specifiche/Specifications	Colore/Color	Note/Notes	Certificazione/Certification
<b>63110.24V</b>	Base piana/Mounting fix	Ambra/ Amber	Oltre 10000 ore di lavoro	ECE R10, ECE R65
<b>63111.24V</b>	Base magnetica/ Magnetic base	Ambra/ Amber	Oltre 10000 ore di lavoro	ECE R10, ECE R65
<b>63112.24V</b>	Base flessibile/ Flexible mount	Ambra/ Amber	Oltre 10000 ore di lavoro	ECE R10, ECE R65

## GIROFARO A LED 12-24V DOPPIA LUMINOSITA'

GYROPHARE LED DOUBLE RANGÉE 12-24V  
LED DUAL ROW BEACON 12-24V  
LED ZWEIREIHIGE LEUCHTE 12-24V  
BALIZA LED DE DOBLE FILA 12-24V



Art./Ref.	Descrizione/Description	Volt/Volt	Watt/Watt	Specifiche/Specifications	Configurazioni/Configurations	Ampere/Ampere	Colore/Color	Materiale/Material	Classe di protezione/Protection class	Temperatura/Temperature	Certificazione/Certification
<b>64495</b>	Base piana	12-24V DC	25W	50 Led	3 modalità flash e 4 modalità di rotazione	12V:2,4A ; 24V:1,04A	590-595 nm	Corpo in alluminio, lente e cover in PC	IP67	-40°C a + 60°C	ECE-R65, ECE-R10, SAE J845, IP67, R25-CLASS3, CE, ROHS.
<b>64496</b>	Base magnetica	12-24V DC	25W	50 Led	3 modalità flash e 4 modalità di rotazione	12V:2,4A ; 24V:1,04A	590-595 nm	Corpo in alluminio, lente e cover in PC	IP67	-40°C a + 60°C	ECE-R65, ECE-R10, SAE J845, IP67, R25-CLASS3, CE, ROHS.
<b>64497</b>	Base flessibile	12-24V DC	25W	50 Led	3 modalità flash e 4 modalità di rotazione	12V:2,4A ; 24V:1,04A	590-595 nm	Corpo in alluminio, lente e cover in PC	IP67	-40°C a + 60°C	ECE-R65, ECE-R10, SAE J845, IP67, R25-CLASS3, CE, ROHS.

**LAMPEGGIANTE LED 12-24V**

GYROPHARE LED 12-24V  
LED BEACON 12-24V  
LED LEUCHTE 12-24V  
BALIZA LED 12-24V

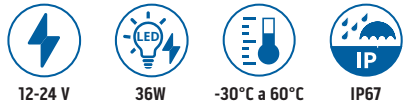
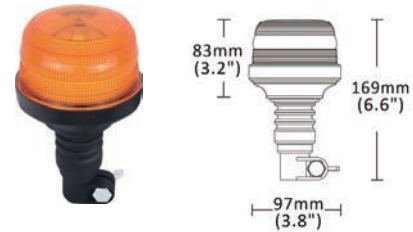

**RICAMBI/ SPARE PARTS**

Art./Ref.	Descrizione
68614	Calotta ricambio
04597	Spina agricola c/cavo spir on/off e flash

Art./Ref.	Descrizione/Description	Configurazioni/Configurations	Colore/Color	Materiale/Material	Certificazione/Certification
68611	Base piana	Sette tipologie di flash: Flash singolo, Doppio flash, Quad flash, Flash veloce, Rotazione, Rotazione+Quad flash, Flash singolo ICAO	Arancione	PC	ECE-R65, ECE-R10, SAE J845, ICAO, CAP168, UKCA, CE
68612	Base magnetica	Flash singolo, Doppio flash, Quad flash, Flash veloce, Rotazione, Rotazione+Quad flash, Flash singolo ICAO	Arancione	PC	ECE-R65, ECE-R10, SAE J845, ICAO, CAP168, UKCA, CE
68613	Base flessibile	Flash singolo, Doppio flash, Quad flash, Flash veloce, Rotazione, Rotazione+Quad flash, Flash singolo ICAO	Arancione	PC	ECE-R65, ECE-R10, SAE J845, ICAO, CAP168, UKCA, CE

**LAMPEGGIANTE LED 10-110V**

GYROPHARE LED 10-110V  
LED WARNING BEACON 10-110V  
DREHLEUCHTE LED 10-110V  
LUZ GIRATORIA LED 10-110V

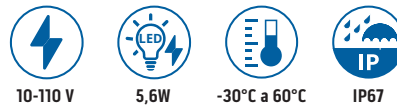
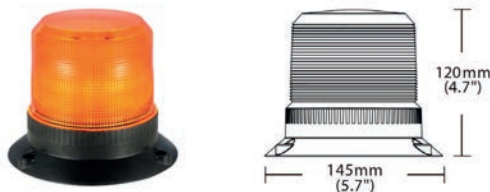

Art./Ref.	Descrizione/Description	Funzioni/Functions	Numero led/Number of LEDs	Diametro/Diameter	Colore/Colour	Assorbimento di corrente/Current consumption	Materiale/Material
68470	Base piana	Quad flash	24	130	Arancione	0,47A-12V; 0,22A-24V; 0,02A-110V	PC

**LAMPEGGIANTE LED 10-110V**

GYROPHARE LED 10-110V  
LED WARNING BEACON 10-110V  
DREHLEUCHTE LED 10-110V  
LUZ GIRATORIA LED 10-110V

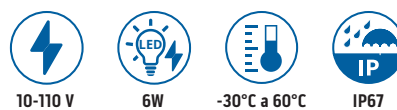
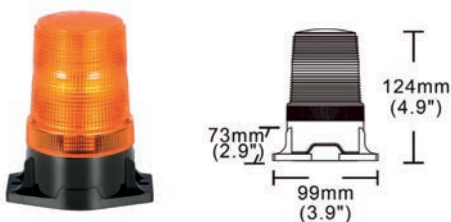

Art./Ref.	Descrizione/Description	Funzioni/Functions	Numero led/Number of LEDs	Fissaggio/Fastening	Colore/Colour	Assorbimento di corrente/Current consumption	Materiale/Material
65121	Base piana	Quad flash	24	2 viti	Arancione	0,5A-12V; 0,23A-24V; 0,02A-110V	PC

### GIROFARI A LED 12-24V

FEU À ÉCLATS 12-24V  
LED BEACON 12-24V  
LED-RUNDUMLEUCHTE 12-24V  
FAROS ROTATIVO 12-24V

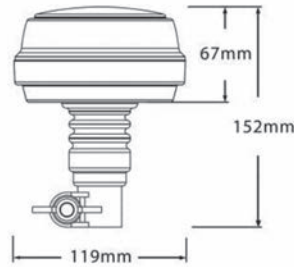

12-24 V



16W



-30°C a 60°C



IP67

Art./Ref.	Colore Colour	Descrizione/Description	Funzioni Functions	Numero led Number of LEDs	Fissaggio Fastening	Assorbimento di corrente Current consumption	Materiale/Material
55415	Verde	Base flex	Rotazione, Flash singolo, Doppio flash, Quad flash	12	Punto più alto del veicolo	0,7 a 12V; 0,4 a 24V	PC
55416	Rosso	Base flex	Rotazione, Flash singolo, Doppio flash, Quad flash	12	Punto più alto del veicolo	0,7 a 12V; 0,4 a 24V	PC

### LUCI DI SEGNALAZIONE PER EMERGENZA

FEUX DE SIGNALISATION D'URGENCE  
EMERGENCY WARNING LIGHT  
NOTSIGNALLEUCHTEN  
LUCES DE SEÑAL DE EMERGENCIA



3,7V - 750mAh



-30°C a 50°C



IP56



BASE MAGNETICA



TEMPO RICARICA



DURATA BATTERIA



#### RICAMBI/ SPARE PARTS

Art./Ref.	Descrizione
68133	Luce a ricambio

Art./Ref.	Descrizione/Description	Configurazioni/Configurations	Materiale/Material	Materiale/Material	Led	Accessori/Accessories	Certificazione/Certification
68132	Base magnetica e gancio appendibile	Rotazione, Quad flash, Flash singolo, Flash intermittente, SOS flash, Luce alta continua, Luce bassa continua, Flash 2 LED, Flash 4 LED, Luce da lavoro	PC+gomma in silicone	ABS	16 arancioni, 3 bianchi	2 cavi di ricarica inclusi	CE, ROHS

### LUCE DI EMERGENZA A LED

LUMIÈRE D'URGENCE À LED  
EMERGENCY WARNING LED LIGHT  
LED-NOTLICHT  
LUZ DE EMERGENCIA LED

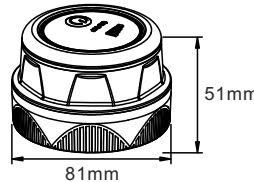

12-24 V DC



IP65



BASE MAGNETICA



TEMPO RICARICA



DURATA BATTERIA



-30°C a 50°C



Battery Status Indicator  
Charging port & External Power supply input port  
On/Off Switch Function Switch



Art./Ref.	Descrizione/Description	Configurazioni/Configurations	Base	Materiale/Material	Batteria/Battery	Specifiche/Specifications	Accessori/Accessories	Certificazione/Certification
77006	Base magnetica	28 LED arancioni + 4 led bianchi	ABS	PC	3,7V @ 2200MA	Flash quintuplo (V16), Flash singolo, Flash SOS arancione, Luce bianca	Cavo di ricarica USB 5V input	CE, ROHS, UKCA

**LUCI DI SEGNALAZIONE ARANCIO A LED 12/24V**

CLIGNOTANT AMBRE' LED 12/24V  
 AMBER WARNING FLASH LAMP LED 12/24V  
 FAHRTRICHTUNGSBLINKLEUCHTE GELB LED 12/24V  
 LUCES DE ADVERTENCIA NARANJA LED 12/24V

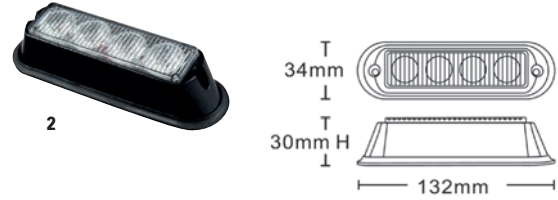
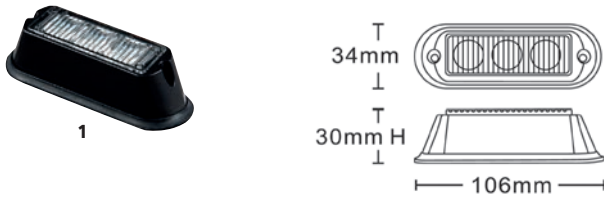

Art./Ref.	Pos.	Led	Descrizione/Description	Colore/Color	Posizione/Position	Dimensioni/Sizes	Note/Notes
64493	1	3	26 varianti di flash con sincronizzazione e funzione di memoria/ 26 flash patterns with synchronization and memory function	Arancio/Amber	IP67	106x34x30 mm	ECE R10, ECE-R65, IP67, CISPR25 Class 3/ECE R10, ECE-R65, IP67, CISPR25 Class 3/ECE R10, ECE-R65, IP67, CISPR25 Class 3/ECE R10, ECE-R65, IP67, CISPR25 Class 3
64494	2	4	26 varianti di flash con sincronizzazione e funzione di memoria/ 26 flash patterns with synchronization and memory function	Arancio/Amber	IP67	132x34x30 mm	ECE R10, ECE-R65, IP67, CISPR25 Class 3/ECE R10, ECE-R65, IP67, CISPR25 Class 3/ECE R10, ECE-R65, IP67, CISPR25 Class 3/ECE R10, ECE-R65, IP67, CISPR25 Class 3

**LUCE DI SEGNALAZIONE FLASH LED ARANCIO 12/24V**

AVERTISSEUR FLASH LED 12/24V  
 WARNING FLASH LAMP LED 12/24V  
 BLITZLEUCHTE LED 12/24V  
 LUCES DE ADVERTENCIA 12/24V

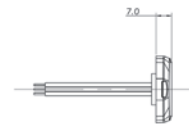
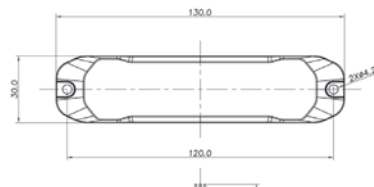
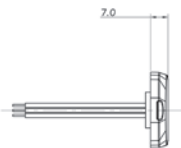
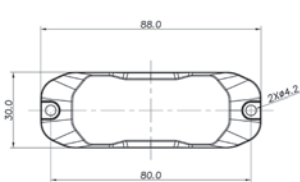
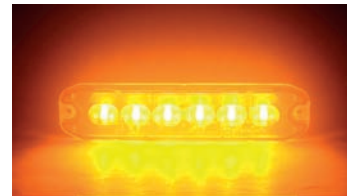

Art./Ref.	Volt/Volt	Colore/Color	Descrizione/Description	Posizione/Position	Watt/Watt	Ampere/Ampere	Classe di protezione/Protection class	Temperatura/Temperature	Materiale/Material	Certificazione/Certification
64468	12-24V DC	Arancio	5 varianti di flash con sincronizzazione e funzione di memoria	Anteriore, posteriore	8W	0,21A a 12V; 0,33A a 24V	IP67	-40°C a + 65°C	Lente in PC; Corpo in alluminio	ECE-R10, ECE-R65, IP67, CISPR 25 Class 3
64469	12-24V DC	Arancio	9 varianti di flash con sincronizzazione e funzione di memoria	Anteriore, posteriore	10W	0,26A a 12V; 0,42A a 24V	IP67	-40°C a + 65°C	Lente in PC; Corpo in alluminio	ECE-R10, ECE-R65, IP67, CISPR 25 Class 3

### PIANTONI SUPPORTO PER GIROFARO

SUPPORTS POUR GYROPHARE  
 BEACOM FOR REVOLVING LAMPS  
 LAGER FÜR RUNDUMLEUCHTE  
 SOPORTE PARA FAROL VOLVEANTE

Note: Bipolari  
 Notes: Two poles

Art./Ref.	Descrizione estesa/Extended Description	Immagine/Image
55360	Piantone per lampeggiante da saldare	
55361	Piantone di supporto per lampeggiante a vite	
55363	Piantone supporto girofaro con attacco a T	
55365	Piantone supporto girofaro con staffa a L	
55362	Piantone per lampeggiante inclinabile 90°	
76499	Piantone inclinabile bipolare	
55364	Piantone supporto girofaro staffa laterale	
55366	Piantone supporto girofaro inclinabile 180°	
55367	Piantone supporto girofaro con staffa lunga laterale	
0A27231	Piantone girofaro in nylon per art. 0A27232	
0A27232	Supporto per piantone girofaro in nylon	

### PRESA BIPOLARE AD INCASSO 6-24V CON CAPPUCCIO

PRISE BIPOLAIRE 6-24V AVEC CAPUCHON  
 HANDLAMP SOCKETS 2-PIN WITH COVER  
 HANDLAMPEN- STECKDOSEN 2-POLING OHNE DECKEL  
 ENCHUFE BIPOLAR C/TAPA



Art./Ref.	Modello/Model	Volt/Volt	Materiale/Material	Dati tecnici/Technical data	Note/Notes
02924	Bipolare	6-24V	Plastica	Connessione a faston 6,3 mm/Connessione a faston 6,3 mm	Con cappuccio/With cover

### PRESA BIPOLARE 12-24V IN ALLUMINIO CON COPERCHIO

PRISE BIPOLAIRE 12-24V AVEC CAPUCHON  
 HANDLAMP SOCKETS WITH COVER  
 HANDLAMPEN- STECKDOSEN 2-POLING OHNE DECKEL  
 ENCHUFE BIPOLAR C/TAPA



Art./Ref.	Modello/Model	Volt/Volt	Materiale/Material	Dati tecnici/Technical data	Note/Notes
P19010	Bipolare	6-24V	alluminio	terminali a faston piatto 6,3 mm	Con coperchio

### PRESA BIPOLARE 12-24V IN PLASTICA CON COPERCHIO

SOCKET 2-PIN WITH COVER



Art./Ref.	Modello/Model	Volt/Volt	Materiale/Material	Dati tecnici/Technical data	Note/Notes
02984	Bipolare	12-24 V	Plastica	terminali a faston piatto 6,3 mm	Con coperchio

### PRESA BIPOLARE 12V IN PLASTICA, CON DUE FORI DI FISSAGGIO.

3 PIN SOCKET



Art./Ref.	Modello/Model	Volt/Volt	Materiale/Material	Dati tecnici/Technical data	Note/Notes
55442	2 poli	12 V	Plastica	terminali a serrafilo	Con coperchio

**PRESE BIPOLARI IN PLASTICA SENZA CAPPuccio**

PRISES DE COURANT BIPOLAIRE SANS CAPUCHON  
 2P HANDLAMP SOCKET WITHOUT COVER  
 2P HANDLAMPEN STECKDOSE OHNE DECKEL  
 TOMA DE CORRIENTE BIPOLAR

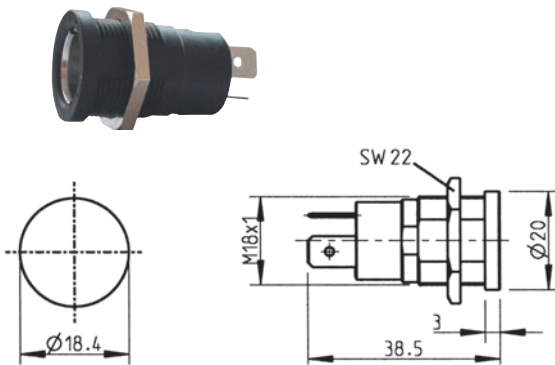

Art./Ref.	Modello/Model	Volt/Volt	Materiale/Material	Dati tecnici/Technical data	Note/Notes
02948	Bipolare/ Dual pole	6-24V	Plastica/ Plastic housing	Connessione a faston 6,3 mm	16A

**PRESA DI CORRENTE 12V ADATTA PER SPINOTTO**

PRISE DE COURANT 12V ADAPTÉE POUR PIN  
 POWER OUTLET 12V SUITABLE FOR PIN  
 STECKDOSE 12V PIN-GEEIGNET  
 TOMA DE CORRIENTE 12V APTO PARA PIN



Art./Ref.	Volt/Volt	Dati tecnici/Technical data	Materiale/Material	Dima mm/Drilling gauge mm
64473	12V	Portata max 15A	Canotto zoccolo in ferro zincato/ Galvanized iron base plinth	Ø 27,8 mm

**CAVO PER GIROFARI**

CABLE POUR GYROPHARES  
 CABLE FOR REVOLVING LAMPS  
 KABEL FÜR RUNDUMLEUCHTE  
 CABLE PARA FAROL VOLVEANTE



Art./Ref.	Pos.	Descrizione/Description	Specifiche/Specifications
02590	1	Cavo spiralato con spina	Torciglione 2X0,75 cm, Lunghezza 45 cm
55444	2	Spina accendisigari	2V 8A con LED di funzionamento
04590	3	Cavo spiralato con spina accendisigari ON/OFF	Cavo spiralato 0.2mm <sup>2</sup> , max lunghezza 3,5 m/Spring cable 0.2mm <sup>2</sup> , max length 3,5 m
04592	4	Spina ON/OFF	8A
66009	5	Cavo spiralato con spina accendisigari per girofaro art. 66010 e 66150	Input: DC 12/24V, 1-15A, 12W-80W; Output: 12V, 1.15A
04597	6	Cavo spiralato con spina ON/OFF e pulsante per selezionare il flash	Cavo spiralato 0.2mm <sup>2</sup> , max lunghezza 3,5 m
04596	7	Adattatore spina accendi sigari	

### PRESA 12V 7 POLI CON PRESA 2 POLI SUPPLEMENTARE

DOUILLE 7 POLE 12V AVEC DOUILLE SUPPLEMENTAIRE 2 POLE  
 7 PIN SOCKET 12V WITH SUPPLEMENTARY 2 PIN SOCKET  
 7 PIN STECKDOSE 12V MIT ZUSATZLICHER 2 PIN STECKDOSENACH  
 12V 7 POLE SOCKET CON 2 POLE SOCKET ADICIONALES



Art./Ref.	Modello/Model	Volt/Volt	Dati tecnici/Technical data	Materiale/Material
19038	7 poli + 2 poli supplementari/ 7 pin + 2 pin supplementary	12V	Terminali piatti 6,3x0,8 mm	Plastica/ Plastic housing

### SPINA PER ALIMENTAZIONE BATTERIA

ADAPTATEUR SECTEUR  
 POWER ADAPTER  
 NETZTEIL  
 ADAPTADOR DE CORRIENTE



Art./Ref.	Specifiche/Specifications
66008	Input: 100-240V, 50V/60Hz, Max 0,8A; Output: 5.0-12V, Max. 2A, Max 12W

### TELECOMANDO PER GIROFARI

TÉLÉCOMMANDE POUR BALISES  
 REMOTE CONTROL FOR BEACONS  
 FERNBEDIENUNG FÜR BAKEN  
 CONTROL REMOTO PARA BALIZAS



Art./Ref.	Specifiche/Specifications
66149	Telecomando per accendere e spegnere il girofaro e cambiare le modalità di lampeggio.

### KIT MAGNETICO

KIT MAGNETIQUE  
 MAGNETIC KIT  
 MAGNETISCHER SATZ  
 KIT MAGNÉTICO



Art./Ref.
03426

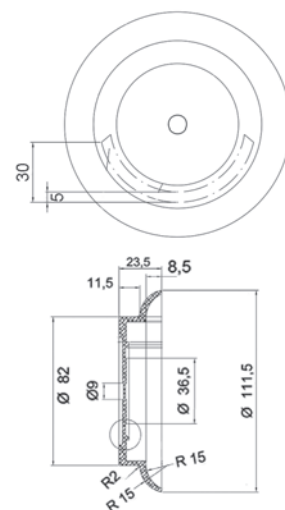

### PORTO GIROFARO

PROTECTION POUR GYROPHARE  
 PROTECTION FOR REVOLVING LAMPS  
 SCHUTZ FÜR RUNDUMLEUCHTE  
 PROTECCIÓN PARA FAROL VOLVEANTE



Art./Ref.	Materiale/Material	Specifiche/Specifications
19412	PVC	Funzione anti-smarrimento: il giunto con occhiello permette di fissare il coperchio al piantone



**IMEL Division**

AMA IMEL DIVISIONE DI AMA S.p.a.  
Via G. di Vittorio, 8  
41011 Campogalliano (MO) Italy  
Tel. +39 0522 6369 (10 linee r.a.) Fax +39 0522 695753  
[www.ama.it](http://www.ama.it) - [ama@ama.it](mailto:ama@ama.it)

**AMA S.p.A.  
Accessori Macchine Agricole**

Via Giacomo Puccini, 28 - 42018 San Martino in Rio (RE) Italy  
Tel. +39 0522 636911 - Fax +39 0522 695753  
[www.ama.it](http://www.ama.it) - [ama@ama.it](mailto:ama@ama.it)

COMPANY WITH  
MANAGEMENT SYSTEM  
CERTIFIED BY DNV  
ISO 9001 • ISO 14001